



---

## INTERNATIONAL REGISTRATION CERTIFICATE

---

The international Bureau of the World Intellectual Property Organization (WIPO) hereby certifies that the particulars given below correspond to the recording made in the International Register of Industrial Designs, at the date of the international registration, under the Hague Agreement Concerning the International Registration of Industrial Designs.

---

*Registration number* **DM/222798**

*Date of the international registration* **27 June 2022**

*Filing date* 27 June 2022

*Name and address of holder* József Lajos SIMON  
Delelő u. 6.  
H-1172 Budapest (Hungary)

### Entitlement

*Nationality* Hungary

*Domicile* Hungary

*Applicant's Contracting Party* Hungary

*Name and address of the representative* DANUBIA SZABADALMI ÉS JOGI IRODA KFT.  
Bajcsy-Zsilinszky út 16.  
H-1051 Budapest (Hungary)

*Name and address of creator of designs* No(s) 1-4: József Lajos SIMON, Delelő utca 6., H-1172, Budapest, Hungary

*Number of designs included in the international registration* 4

*Locarno Classification* Cl. 02-04, 02-07, 02-99

*Indication of products* No(s) 1: Ankle protector  
No(s) 2: Knee protector  
No(s) 3: Elbow protector  
No(s) 4: Shoulder protector

*Description* No(s) 1-4: The design is characterized by a special contour and a specially segmented surface.



---

**INTERNATIONAL REGISTRATION CERTIFICATE** (continued) **DM/222798**

---

*Claim* US : The ornamental design for an ankle protector, knee protector, elbow protector, shoulder protector, as shown and described

*Contracting Parties designated under the 1999 Act* China, Norway, Switzerland, United Kingdom, United States of America

*Related and Main/Principal Designs*

<i>CP</i>	<i>Related design(s)</i>	<i>Main or principal design</i>
CN	--	The present application WIPO119031 Design no. 1

*Data relating to priority under the Paris Convention* No(s) 1-4: 28 March 2022, 008919690-0001/008919690-0004, European Union



---

**INTERNATIONAL REGISTRATION CERTIFICATE** (continued) **DM/222798**

---

1.1  
Not specified

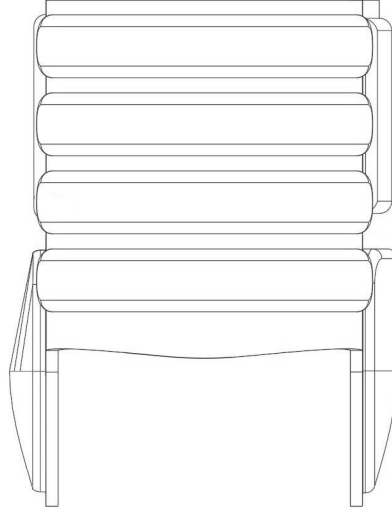

1.2  
Not specified

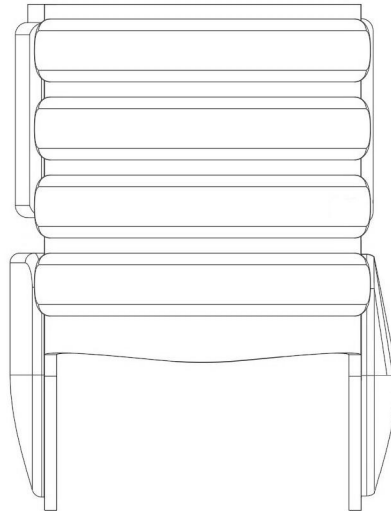



---

**INTERNATIONAL REGISTRATION CERTIFICATE** (continued) **DM/222798**

---

1.3  
Not specified

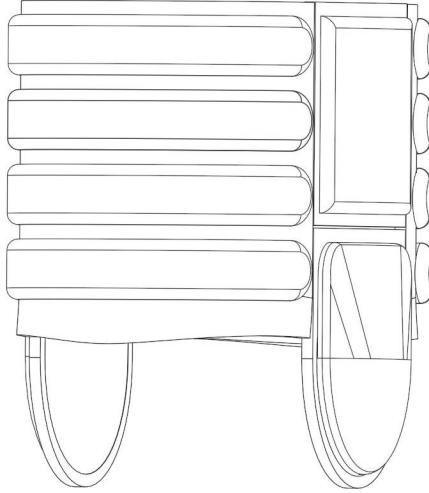

1.4  
Not specified

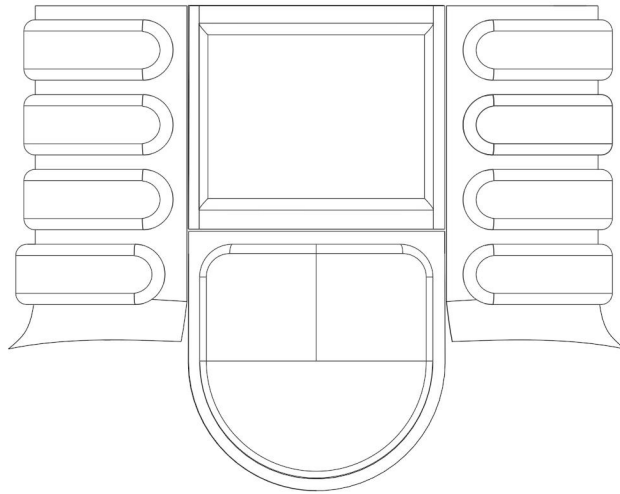



---

**INTERNATIONAL REGISTRATION CERTIFICATE** (continued) **DM/222798**

---

1.5  
Not specified

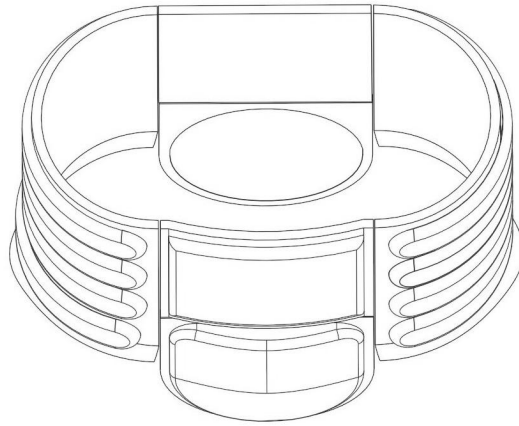

1.6  
Not specified

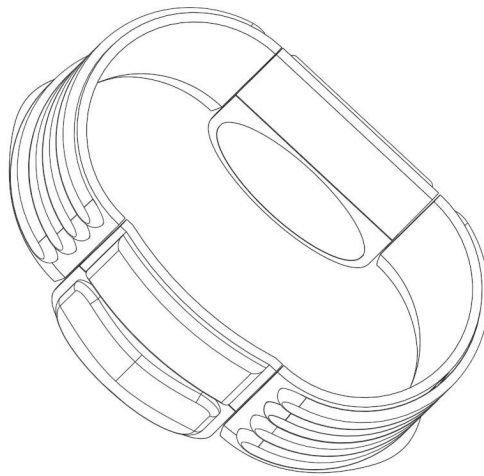



1.7  
Not specified

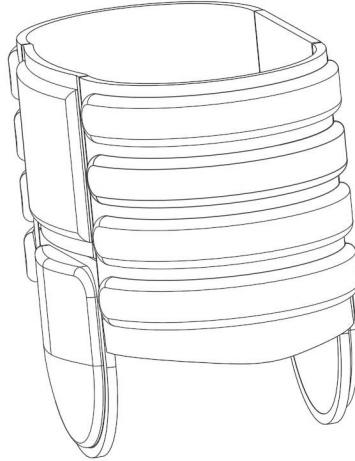

2.1  
Not specified

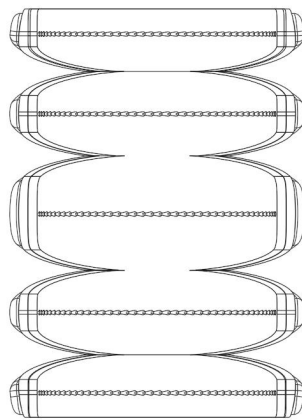



2.2  
Not specified

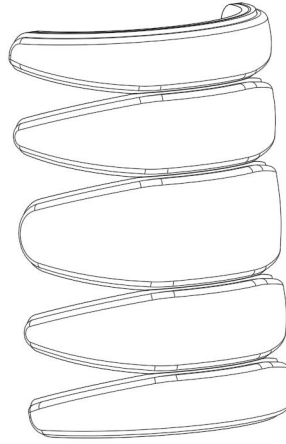

2.3  
Not specified

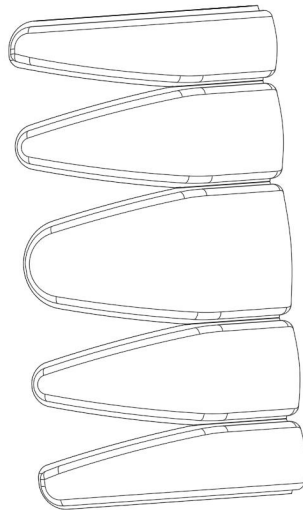



2.4  
Not specified

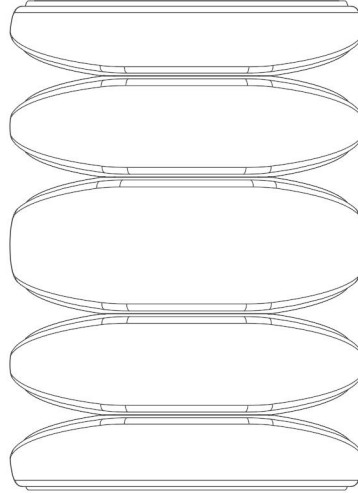

2.5  
Not specified

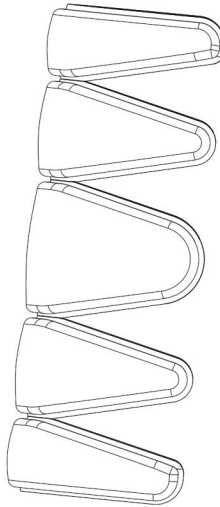





---

**INTERNATIONAL REGISTRATION CERTIFICATE** (continued) **DM/222798**

---

2.6  
Not specified

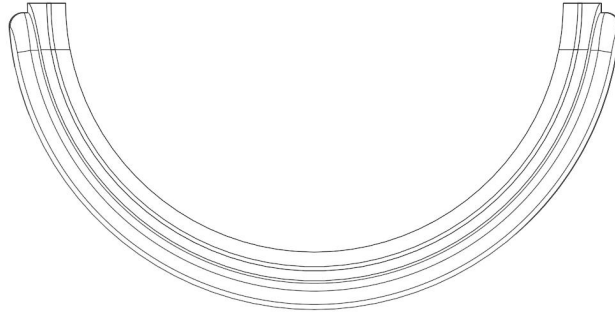

3.1  
Not specified

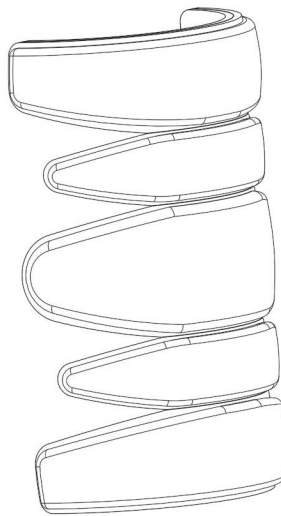



3.2  
Not specified

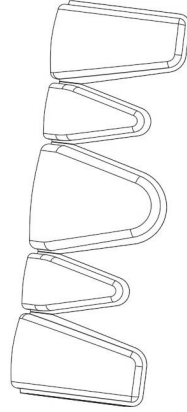

3.3  
Not specified

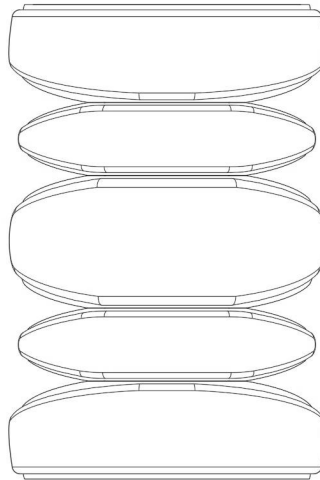



3.4  
Not specified

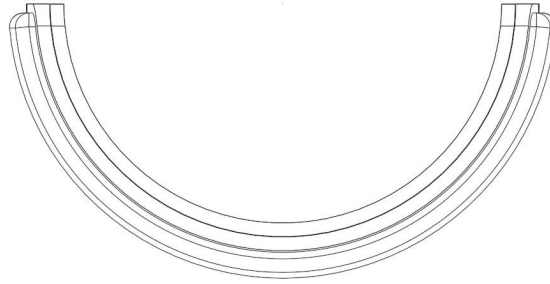

3.5  
Not specified

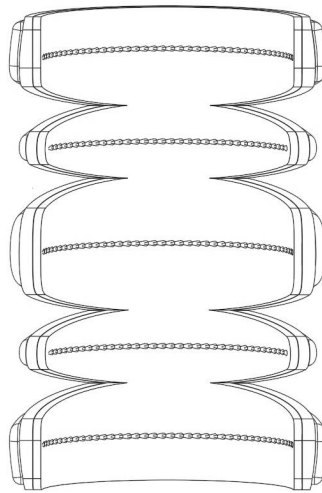



3.6  
Not specified

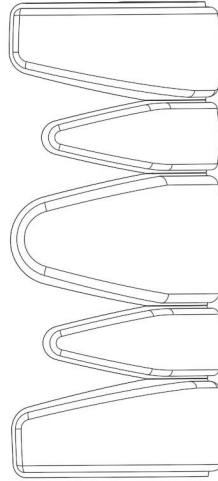

4.1  
Not specified

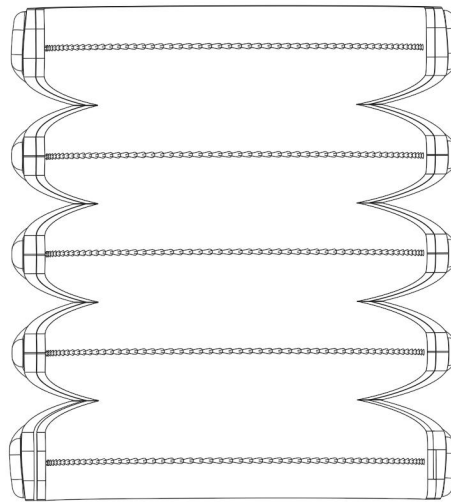



4.2  
Not specified

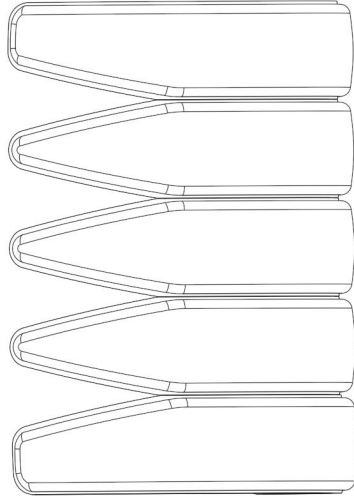

4.3  
Not specified

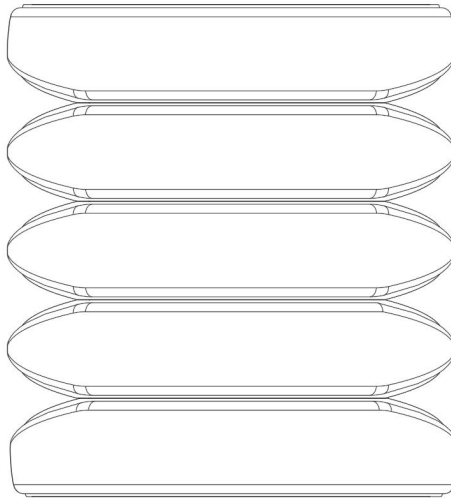



4.4  
Not specified

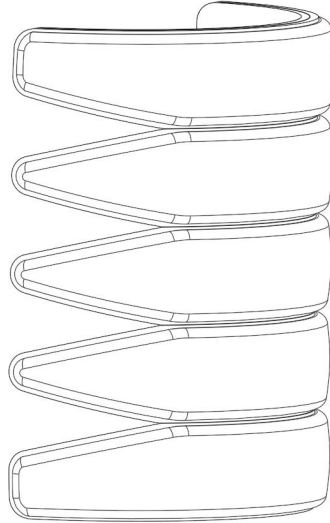

4.5  
Not specified

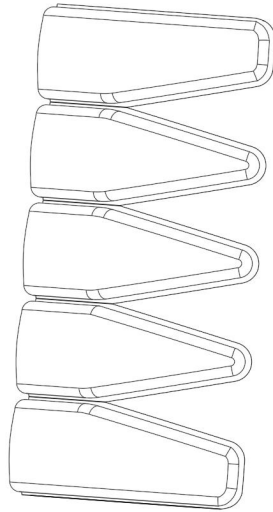



---

**INTERNATIONAL REGISTRATION CERTIFICATE** (continued) **DM/222798**

---

4.6  
Not specified

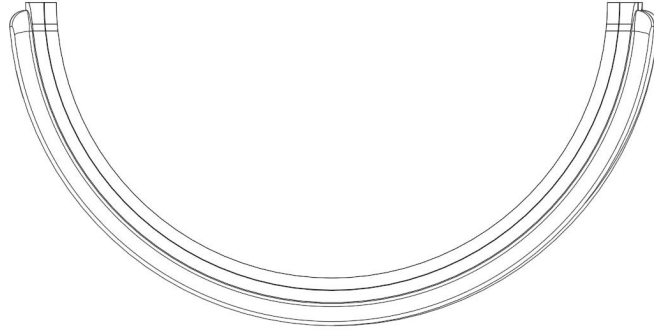

Quan-Ling SIM  
Head, Operations Service  
The Hague Registry  
Brands and Designs Sector

August 17, 2022



---

## PAYMENT BALANCE

---

International registration: DM/222798

User ref.: 134407HS - HG

August 17, 2022

Swiss Francs

International registration basic fee (IB)	397.00
International registration fee for additional designs (IB)	57.00
Standard designation fee 1 (GB)	42.00
Standard designation fee 2 (CH, NO)	120.00
Standard designation fee for additional designs 1 (GB)	6.00
Standard designation fee for additional designs 2 (CH, NO)	120.00
Individual designation fee (CN)	603.00
Part 1 of 2 of Individual Designation Fee (Undiscounted) (US)	989.00
Publication of reproductions (IB)	425.00
<b>Total due:</b>	<b>2,759.00</b>
Payment received on 27 June 2022	2,759.00